



# TM05N02MI

# N-Channel Enhancement Mosfet

<p><b>General Description</b></p> <ul style="list-style-type: none"> <li>• Low <math>R_{DS(ON)}</math></li> <li>• RoHS and Halogen-Free Compliant</li> </ul> <p><b>Applications</b></p> <ul style="list-style-type: none"> <li>• Load switch</li> <li>• PWM</li> </ul>	<p><b>General Features</b></p> <p><math>V_{DS} = 20V</math> <math>I_D = 5.2A</math>  <math>R_{DS(ON)} = 21m\Omega (typ.) @ V_{GS} = 4.5V</math></p> <p>100% UIS Tested          100% <math>R_g</math> Tested</p> 
--	--

MI: SOT-23-3L

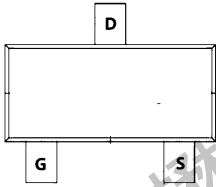
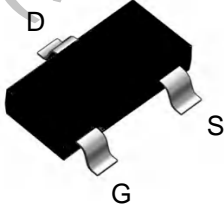
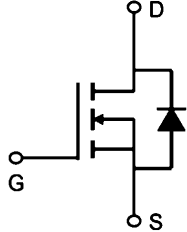
Marking: 2300 OR AE9T

**Absolute Maximum Ratings ( $T_C = 25^\circ C$  unless otherwise noted)**

Symbol	Parameter	Rating	Units
$V_{DS}$	Drain-Source Voltage	20	V
$V_{GS}$	Gate-Source Voltage	$\pm 12$	V
$I_D @ T_A = 25^\circ C$	Continuous Drain Current, $V_{GS} @ 4.5V$	5.2	A
$I_D @ T_A = 100^\circ C$	Continuous Drain Current, $V_{GS} @ 4.5V$	3.4	A
$I_{DM}$	Pulsed Drain Current	19.4	A
$E_{AS}$	Single Pulsed Avalanche Energy	25	mJ
$P_D @ T_A = 25^\circ C$	Total Power Dissipation	1.0	W
$T_{STG}$	Storage Temperature Range	-55 to 150	$^\circ C$
$T_J$	Operating Junction Temperature Range	-55 to 150	$^\circ C$

**Thermal Data**

Symbol	Parameter	Typ.	Max.	Unit
$R_{\theta JA}$	Thermal Resistance Junction-ambient	---	48	$^\circ C/W$
$R_{\theta JC}$	Thermal Resistance Junction-Case	---	---	$^\circ C/W$

**TM05N02MI**
**N-Channel Enhancement Mosfet**
**Electrical Characteristics** ( $T_J=25^{\circ}\text{C}$  unless otherwise specified)

Symbol	Parameter	Test Condition	Min.	Typ.	Max.	Units
<b>Off Characteristic</b>						
$V_{(BR)DSS}$	Drain-Source Breakdown Voltage	$V_{GS}=0V, I_D=250\mu A$	20	-	-	V
$I_{DSS}$	Zero Gate Voltage Drain Current	$V_{DS}=20V, V_{GS}=0V,$	-	-	1.0	$\mu A$
$I_{GSS}$	Gate to Body Leakage Current	$V_{DS}=0V, V_{GS}=\pm 12V$	-	-	$\pm 100$	nA
<b>On Characteristics</b>						
$V_{GS(th)}$	Gate Threshold Voltage	$V_{DS}=V_{GS}, I_D=250\mu A$	0.5	0.7	0.9	V
$R_{DS(on)}$	Static Drain-Source on-Resistance <small>note2</small>	$V_{GS}=4.5V, I_D=4A$	-	21	29	m $\Omega$
		$V_{GS}=2.5V, I_D=3A$	-	28	44	
<b>Dynamic Characteristics</b>						
$C_{iss}$	Input Capacitance	$V_{DS}=10V, V_{GS}=0V,$ $f=1.0MHz$	-	258	-	pF
$C_{oss}$	Output Capacitance		-	69.3	-	pF
$C_{rss}$	Reverse Transfer Capacitance		-	58.5	-	pF
$Q_g$	Total Gate Charge	$V_{DS}=10V, I_D=2A,$ $V_{GS}=4.5V$	-	5.6	-	nC
$Q_{gs}$	Gate-Source Charge		-	0.8	-	nC
$Q_{gd}$	Gate-Drain("Miller") Charge		-	1	-	nC
<b>Switching Characteristics</b>						
$t_{d(on)}$	Turn-on Delay Time	$V_{DS}=10V,$ $I_D=4A, R_{GEN}=3\Omega,$ $V_{GS}=4.5V$	-	5	-	ns
$t_r$	Turn-on Rise Time		-	30	-	ns
$t_{d(off)}$	Turn-off Delay Time		-	48	-	ns
$t_f$	Turn-off Fall Time		-	36	-	ns
<b>Drain-Source Diode Characteristics and Maximum Ratings</b>						
$I_S$	Maximum Continuous Drain to Source Diode Forward Current		-	-	5.2	A
$I_{SM}$	Maximum Pulsed Drain to Source Diode Forward Current		-	-	19.4	A
$V_{SD}$	Drain to Source Diode Forward Voltage	$V_{GS}=0V, I_S=4A$	-	-	1.2	V

**Typical Performance Characteristics**

**Figure 1: Output Characteristics**

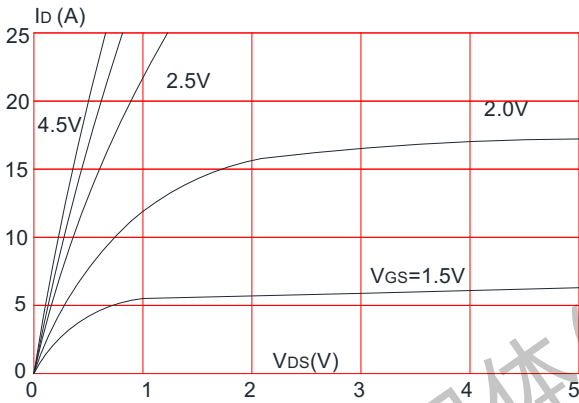

**Figure 2: Typical Transfer Characteristics**

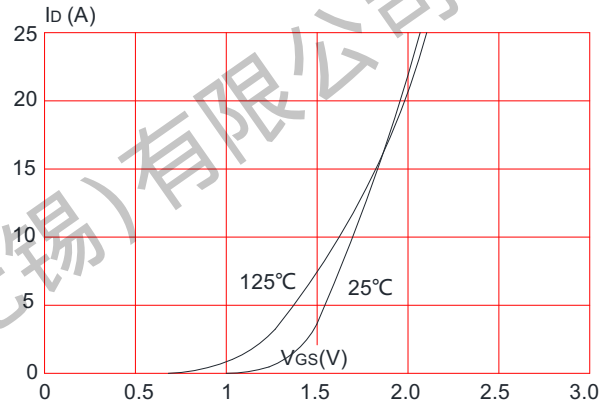

**Figure 3: On-resistance vs. Drain Current**

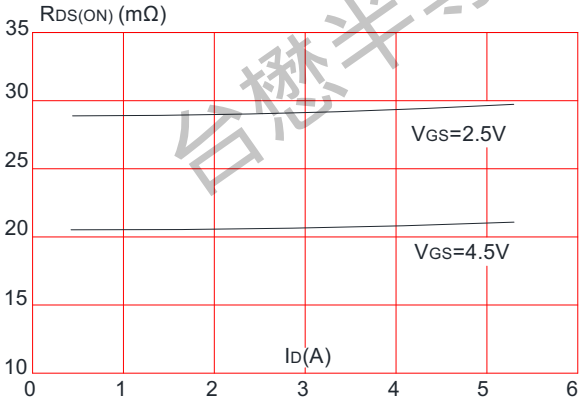

**Figure 4: Body Diode Characteristics**

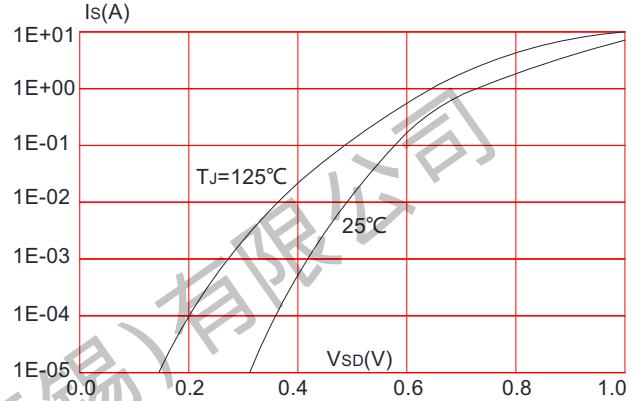

**Figure 5: Gate Charge Characteristics**



**Figure 6: Capacitance Characteristics**

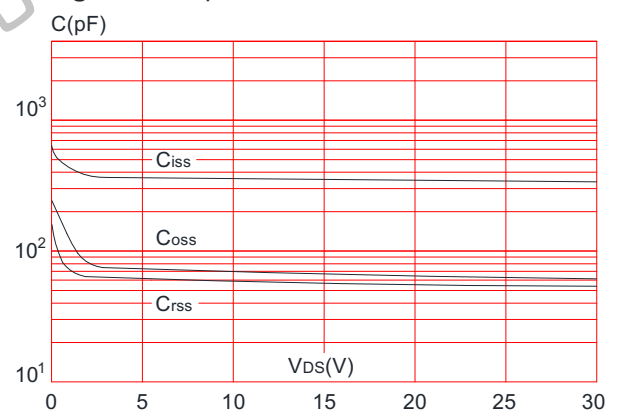

**TM05N02MI**

**N-Channel Enhancement Mosfet**

**Figure 7:** Normalized Breakdown Voltage vs. Junction Temperature

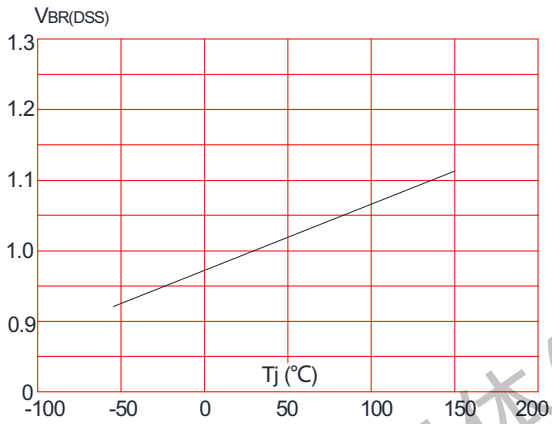

**Figure 8:** Normalized on Resistance vs. Junction Temperature

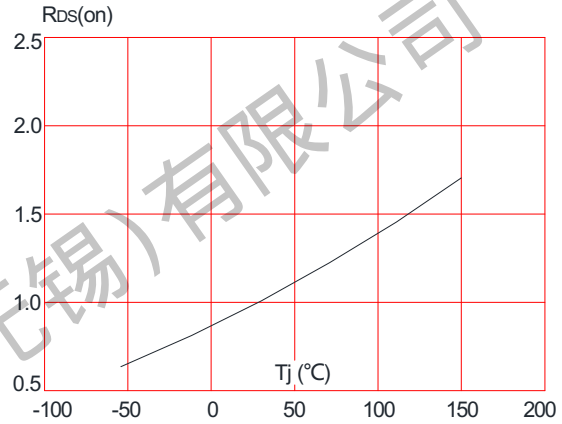

**Figure 9:** Maximum Safe Operating Area

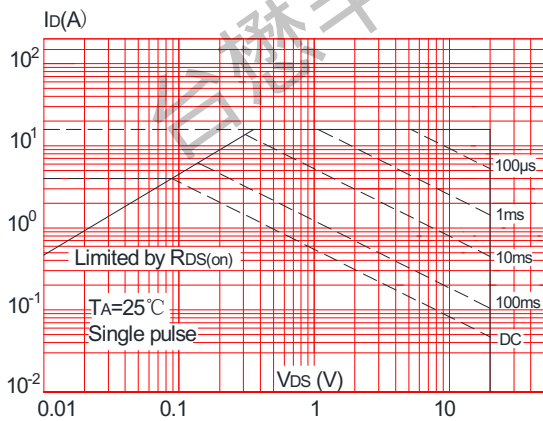

**Figure 10:** Maximum Continuous Drain Current vs. Ambient Temperature

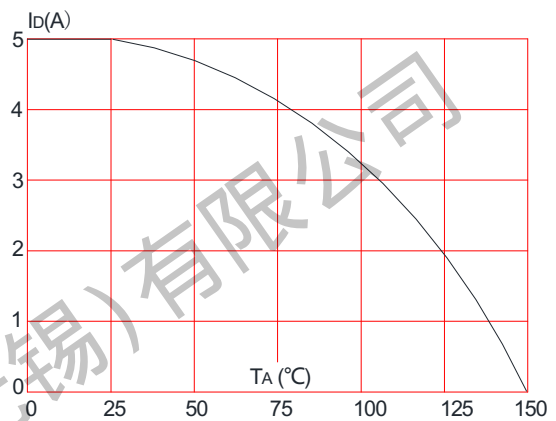

**Figure.11:** Maximum Effective Transient Thermal Impedance, Junction-to-Ambient

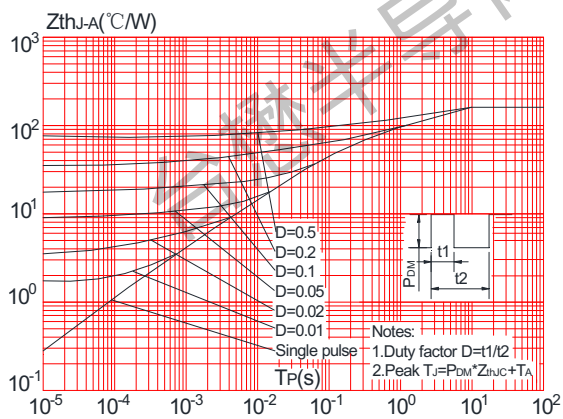



TM05N02MI

N-Channel Enhancement Mosfet

Package Mechanical Data:SOT-23-3L

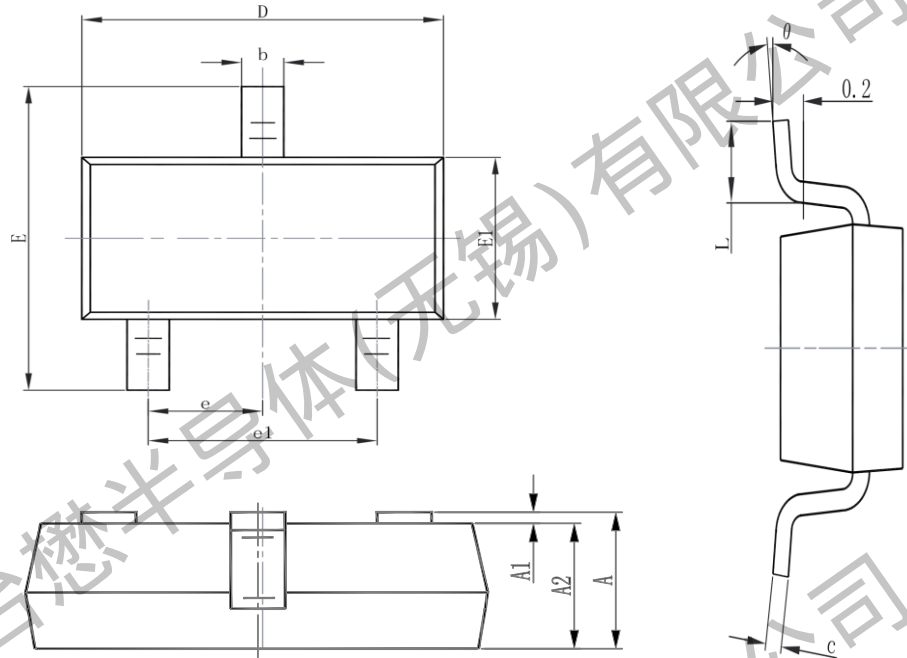

Symbol	Dimensions In Millimeters		Dimensions In Inches	
	Min.	Max.	Min.	Max.
A	1.050	1.250	0.041	0.049
A1	0.000	0.100	0.000	0.004
A2	1.050	1.150	0.041	0.045
b	0.300	0.500	0.012	0.020
c	0.100	0.200	0.004	0.008
D	2.820	3.020	0.111	0.119
E1	1.500	1.700	0.059	0.067
E	2.650	2.950	0.104	0.116
e	0.950(BSC)		0.037(BSC)	
e1	1.800	2.000	0.071	0.079
L	0.300	0.600	0.012	0.024
θ	0°	8°	0°	8°



# TM05N02MI

# N-Channel Enhancement Mosfet

## SOT-23-3L Packing

1. The method of packaging and dimension are shown as below figure. (Dimension in mm)

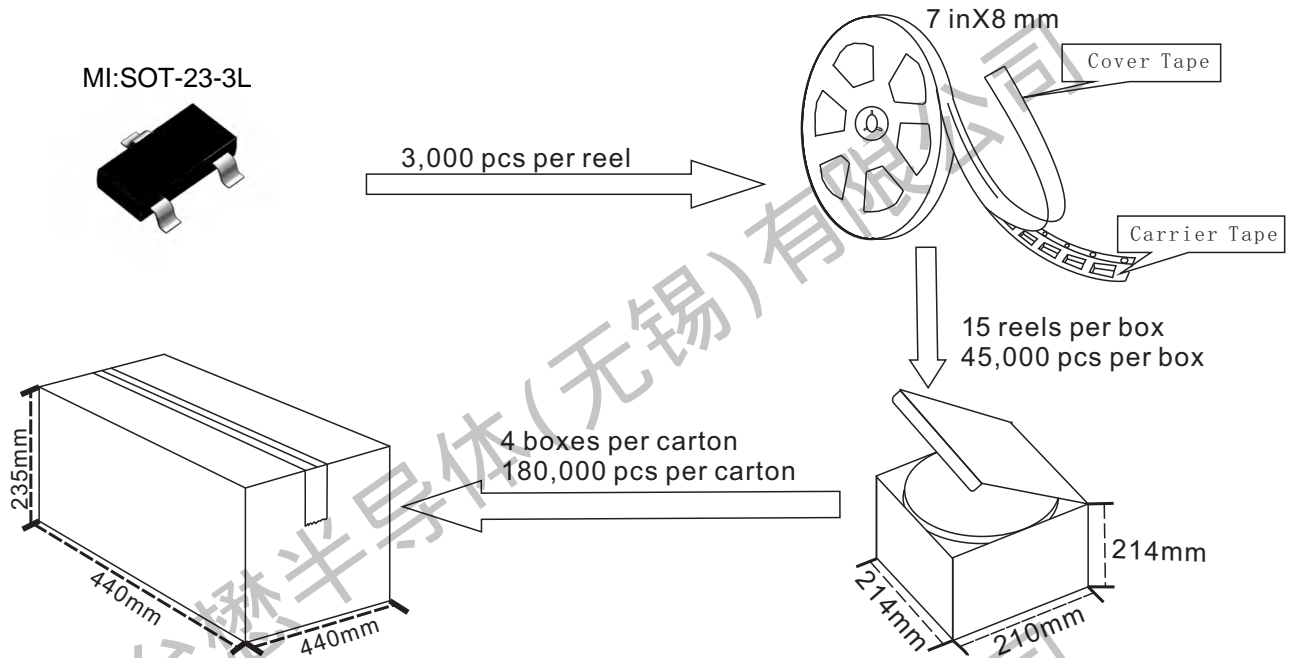

### SOT-23-3L Embossed Carrier Tape

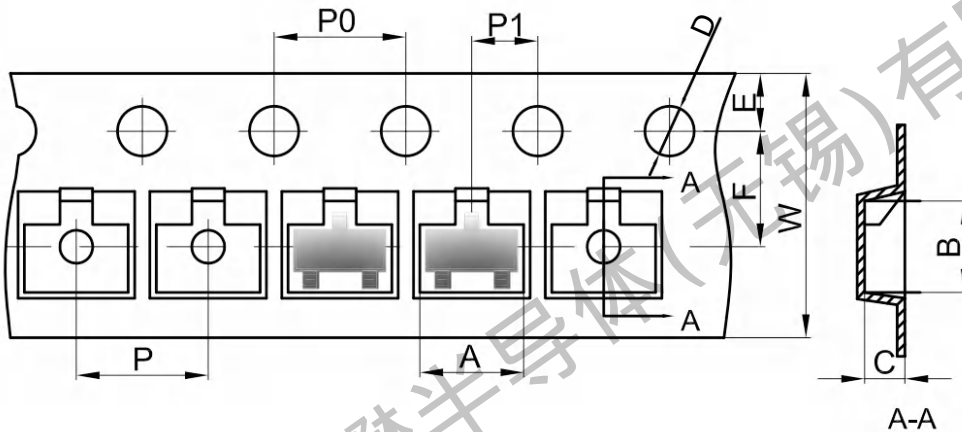

Dimensions are in millimeter

Pkg type	A	B	C	D	E	F	P0	P	P1	W
SOT-23-3L	3.15	2.77	1.22	Ø1.50	1.75	3.50	4.00	4.00	2.00	8.00

### SOT-23-3L Tape Leader and Trailer

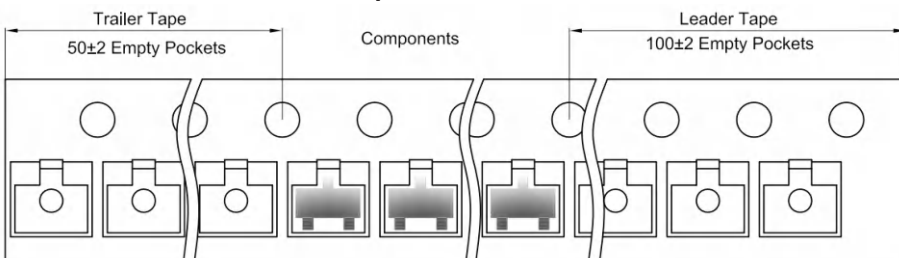



### Important Notices and Disclaimers

- Tritech-MOS Technology Corp.reserves the right to change thisdocument, its products, and specifications at any time without prior notice.
- Before final design, purchase, or use, customers should obtain and confirm the latest product information and specifications.
- Tritech-MOS Technology Corp. makes no warranties, representations or warranties regarding the suitability of its products for any specific purpose, and Tritech-MOS Technology Corp. does not assume any responsibility for application assistance or customer product design.
- Tritech-MOS Technology Corp. does not guarantee or assume any responsibility for the purchase or use of any unexpected or unauthorized products.
- Any intellectual property rights of Tritech-MOS Technology Corp. are not licensed through implicate or other means.
- Products of Tritech-MOS Technology Corp. are not included as critical components in life support equipment or systems without explicit written approval from Tritech-MOS Technology Corp.

Revision history:

Date	Rev	Description	Page
2023.05.10	23.05	Original	